



Player One

# Uranus-C Pro Camera Manual

V1.0

Dec, 2024

## Table of Contents

Product Features .....	3
Technical parameters .....	4
Product Description .....	5
STARVIS Technology .....	5
Format .....	5
Cutting-edge Design .....	6
Front 3P and Rear 4P tilter plate .....	6
Carbon fiber and light weight .....	7
Deep Cooling .....	8
Anti-Dew heater .....	8
Full well .....	9
Frame rate .....	9
Non-Amp-Glow .....	10
512MB DDR3 Cache .....	10
Type-C Data port and Power port .....	11
Standard Cable Usage .....	12
Cooling System and Anti-Dew Heater .....	12
Overvoltage and overcurrent protection mechanism .....	12
Performance .....	13
Readout Noise .....	14
Dark current .....	14
Relative QE Curve .....	15
Mechanical Drawing .....	16
BFL Solutions .....	17
Package List .....	19
Warranty & Shipping Policy .....	20

## Product Features

DSO cooled camera line is the most advanced product line in Player One history. We start the project from 2021, through a lot of modify and rebuild we made this final version. It brings our newest technology and design to everyone, we are very proud to introduce this camera line.

### Sony IMX585 Color

Non-Amp-Glow Back-illuminated Sensor

**1/1.2"**  
8.3 Mega Pixels

**12bit**  
ADC bit depth

**47FPS**  
3856×2180

**9.1%**  
QE Peak

**0.7e**  
Readout Noise

**47Ke**  
Full Well



**Front 3P+Rear 4P**  
Alternative Sensor Tilt Plate

**512MB**  
DDR3 buffer

**Anti Dew**  
Adjustable Dew Heater

**Delta-T 40°C**  
Deep Cooling

**Type-C**  
USB3.0 port

**BFL Solution**  
Complete Imaging Train Solutions

New entry level camera for DSO imaging

Uranus-C PRO camera is first IMX585 cooled camera in the world! Based on Player One's technology, Uranus-C Pro has 38.8Ke full well, 0.7e ultra low readout noise and it can run 47fps under full resolution. With high quality 2 Stage TEC unit, Uranus Pro camera can cooling down 35-40 °C below the ambient. Non-Amp-Glow BSI sensor make this camera has enough ability to open the gate of DSO (Deep Sky Object) imaging.

## Technical parameters

<b>Sensor</b>	New SONY IMX585 1/1.2" CMOS (color)
<b>Diagonal</b>	12.85mm
<b>Total Pixels</b>	8.3 Mega Pixels
<b>Max Resolution</b>	3856x2180
<b>Pixel Size</b>	2.9 $\mu$ m
<b>Bayer Pattern</b>	RGGB
<b>Chip Size</b>	11.2mmx6.3mm
<b>Frame Rate</b>	47FPS (10bit)
<b>Shutter</b>	Rolling shutter
<b>Exposure Range</b>	32 $\mu$ s-2000s
<b>Readout Noise</b>	6.5-0.7e
<b>Full Well</b>	47k e
<b>QE Peak</b>	$\approx$ 91%
<b>ADC</b>	12 bit
<b>Cooling System</b>	High quality 2 stage TEC cooling Component
<b>Cooler Power Consumption</b>	12V – 3A Max
<b>Delta T</b>	35°C-40°C (below ambient)
<b>Working Temperature and Humidity</b>	Working Temperature: -10°C—60°C Working Relative Humidity: 0%—80%
<b>Protective Window</b>	D32*2MM High Quality AR Plus (Anti Reflection) Multi-Layer Coating
<b>Data Port</b>	USB3.0/USB2.0
<b>Adapter</b>	1.25" / M42X0.75
<b>Back Focal Length</b>	17.5mm
<b>Diameter</b>	78mm
<b>Weight</b>	420g
<b>Resolution and FPS</b>	FPS Under USB3.0 mode Resolution 10bit ADC 3856x2180 46FPS 3840x2160 47FPS 1920x1080 187FPS More resolution options could be setup in capture software!

## Product Description

Uranus-C Pro (IMX585) camera is developed by Player One Astronomy, it's first IMX585 cooled camera in the world. Uranus-C Pro camera, which adopts **Sony IMX585 1/1.2" format** color sensor. The **2.9um pixel size** accommodates a well depth of **47Ke** with a total of **8.3MP** (the resolution is 3856\*2180), and the diagonal is **12.85mm**.

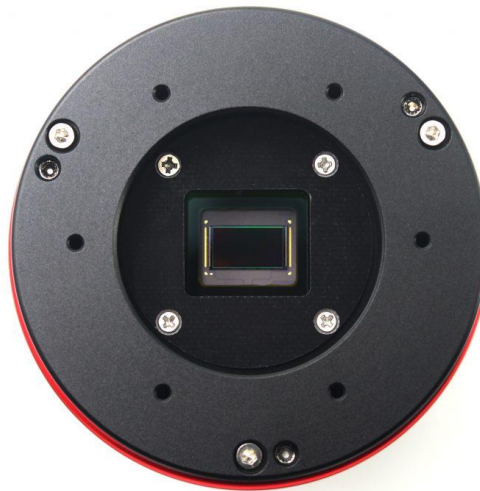

## STARVIS Technology

Uranus-C Pro (IMX585) camera based on **Sony STARVIS2 technology**, it is back-illuminated pixel technology used in CMOS image sensors.

## Format

Uranus-C Pro camera has 1/1.2" format; this size is quite big for imaging.

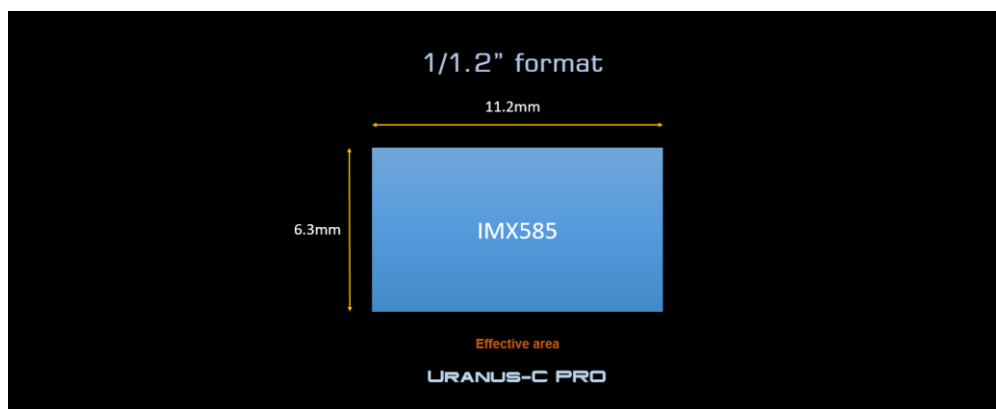

## Cutting-edge Design

The Uranus-C Pro cooled camera using same design as Ares cooled series! With a round body, a classic red and black color scheme, and using carbon fiber to keep weight down and cutting-edge outlook. We also integrated the sensor tilter plate and anti-dew PCB board. This series of designs makes the camera not only light and cool, but also functional!



## Front 3P and Rear 4P tilter plate

When shooting deep sky objects, the sensor tilt plate can be used to adjust the sensor tilt angle to make the stars at the corners more rounded. Uranus-C Pro camera provide both front and Rear tilter plate fulfill all usage scenarios.

### Front 3P sensor tilter plate

For basic connection



### Rear 4P sensor tilter plate

To connect Phoenix Wheel, Filter Drawer and OAG with fixed angel



**Front 3P tilter plate** is the default part on camera, we believe most users has experience with this before. it works well in a lot of basic scenarios.

**Rear 4P tilter plate** is an alternate part for camera, when use filter wheel/filter drawer and OAG with fixed angel, it is necessary. And it is also convenient for RASA users to adjust the sensor tilt angel.

The built-in high-density sponge shading pad can block the light from the side slits without any side leakage.

### Carbon fiber and light weight

The Uranus-C Pro uses a carbon fiber in camera housing and has been optimized for weight reduction in its structural design. The camera weighs only 420 grams, making it one of the lightest models on the market.



## Deep Cooling

Player One cooled camera series use 2 Stage TEC Cooling unit, after improved the structure design to reject the heat back to camera chamber, Camera **Delta-T** can reach **35-40°C**.

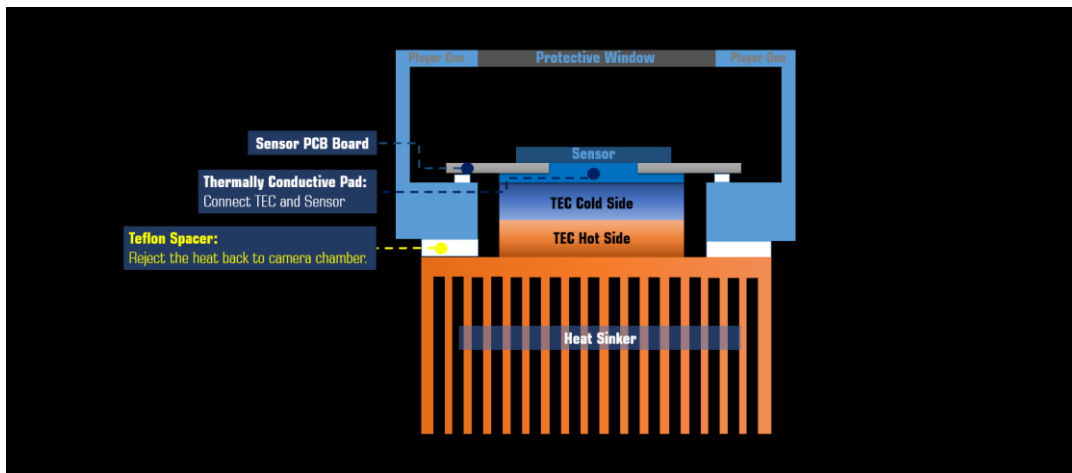

## Anti-Dew heater

In the design of lightweight cooled cameras, Player One still pursuing the perfection, any necessary features must have, especially anti-dew system, is the problem that a lot of small cooled cameras ignored.



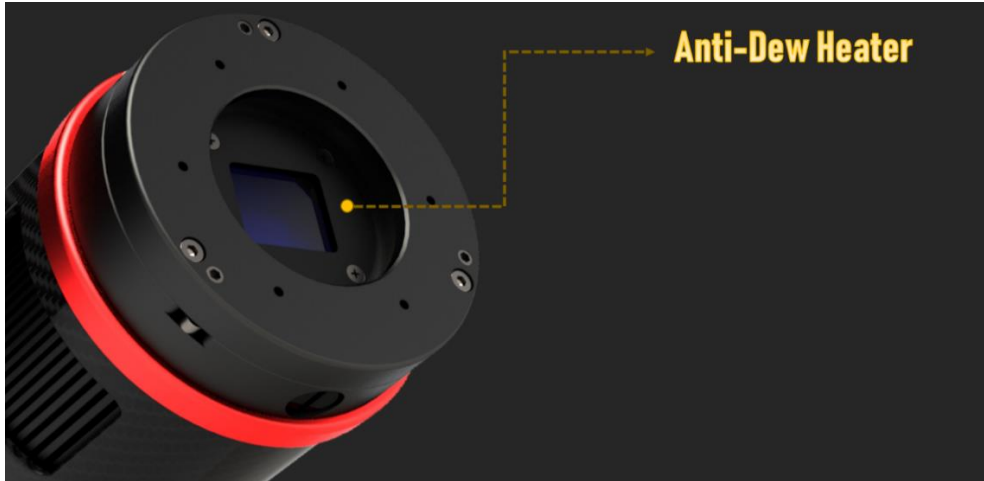

### Full well

Uranus-C Pro camera has 47Ke full well, it's almost 3.6 times than previous generation IMX485 (13ke).

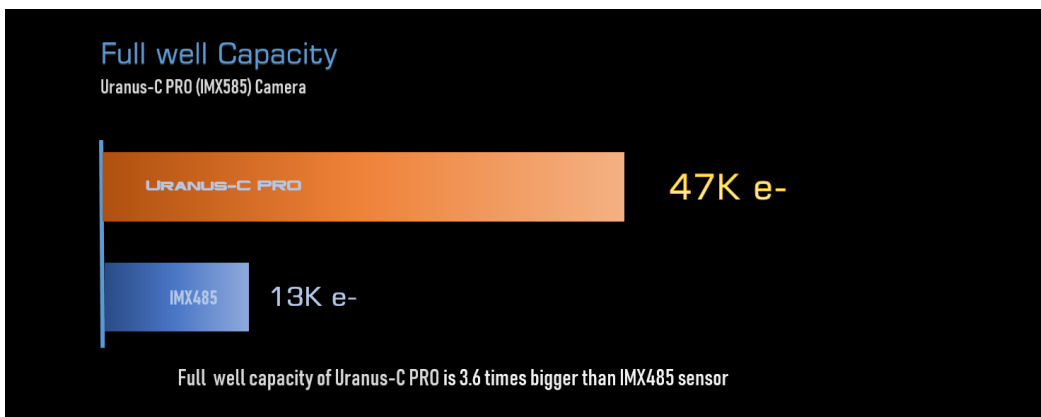

### Frame rate

Uranus-C Pro camera can run 47FPS under RAW8 mode, that's much faster than IMX485 cameras.

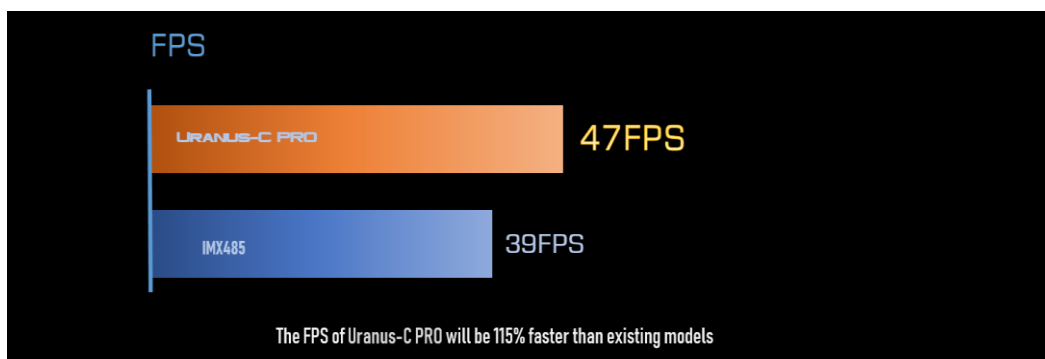

## Non-Amp-Glow

Dark frame of Uranus-C Pro camera is totally “dark”, it is also “Non-Amp-Glow” camera too!

300s@gain=0, offset=10, -10 degree, Dark frame of Uranus-C Pro camera: [DOWNLOAD](#)

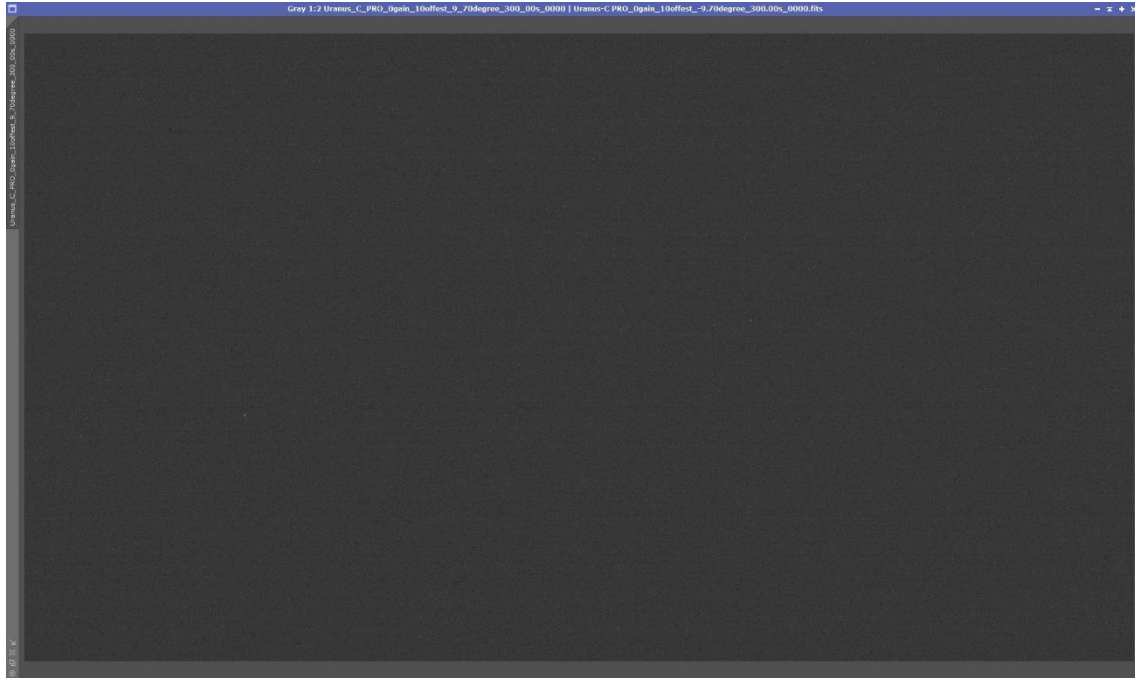

*Preview of Dark frame: Exposure=300s, gain=0, offset=10, temp=-10°C STF auto-Stretch in Pixinsight 1.86*

Non-Amp-Glow can give us very clean background, much easier to get high quality images.

Uranus-C Pro camera also very good for solar, lunar and planetary imaging. Its 1/1.2" sensor can easily capture full disk of the Sun and Moon with short focal refractors. And it also could make mosaic work more efficient.

## 512MB DDR3 Cache

As an improvement, DDR3 cache in cooled cameras are increased to 512MB. It helps stabilize and secure data transmission, it effectively avoids frame dropping and greatly reduces readout noise.

With the DDR3 cache, the camera does not have high demands on computing needs any longer, it will still have excellent performance even if it is connected to a USB 2.0 port.

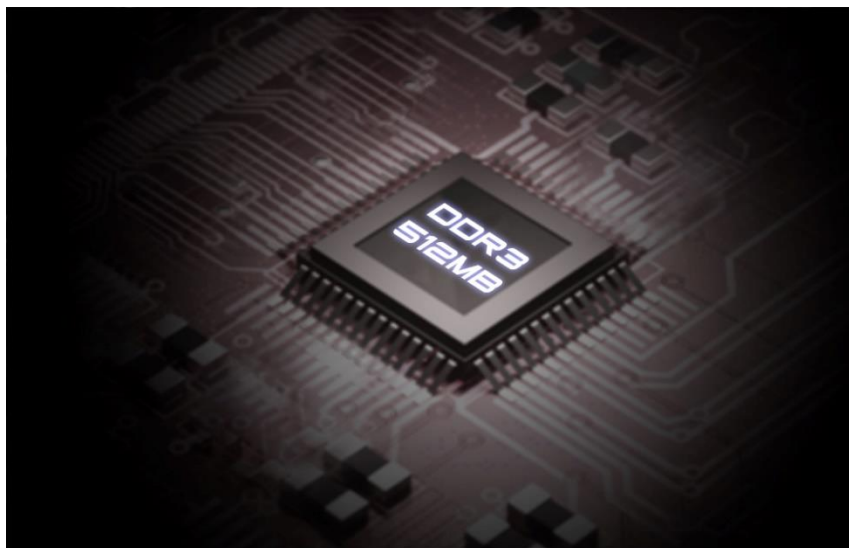

### Type-C Data port and Power port

Back piece of cooled camera has 2 Type-C data port and 12V DC 5.5x2.1mm power port.



Main data port support USB3.0 protocol, the camera can run 47fps under RAW8 mode. Type-C port is easier to plug in when assemble the imaging equipment in night.

When recording images, since the actual writing speed will be affected by the writing speed of the hard disk itself, when the hard disk writing speed is slow, the recording may not reach the theoretical speed. It is recommended that you use a high-quality solid state drive to record data to give full play to the performance of the camera.

The camera has 12V DC5.5\*2.1mm port to provide enough power to TEC cooling system. If you don't need to power up cooling, only need to connect the main Type-C port, the camera will work as an uncooled camera.

## Standard Cable Usage



## Cooling System and Anti-Dew Heater

In ASCOM window, we provide 3 adjustable parameters: Target temperature, Fan Speed and Anti-Dew power.

Standard Delta-T: 35°C-40°C, when ambient temp 30°C, fan speed 100%, dew heater 1%.

Recommend Delta-T settings: 30°C-35°C below ambient, fan speed 50-70%, dew heater 10%, power consumption 40- 60%.

The rotation speed of cooling fan is also adjustable; the default value is 50% speed.

Dew problem is the biggest enemy in astro imaging, the camera integrated anti-dew heater in front of the camera. The heat power is adjustable.

## Overvoltage and overcurrent protection mechanism

Player One cameras produced by the number one player ensures the safety of your camera and other equipment through overvoltage and overcurrent protection mechanisms.

## Performance

HCG open at gain=210.

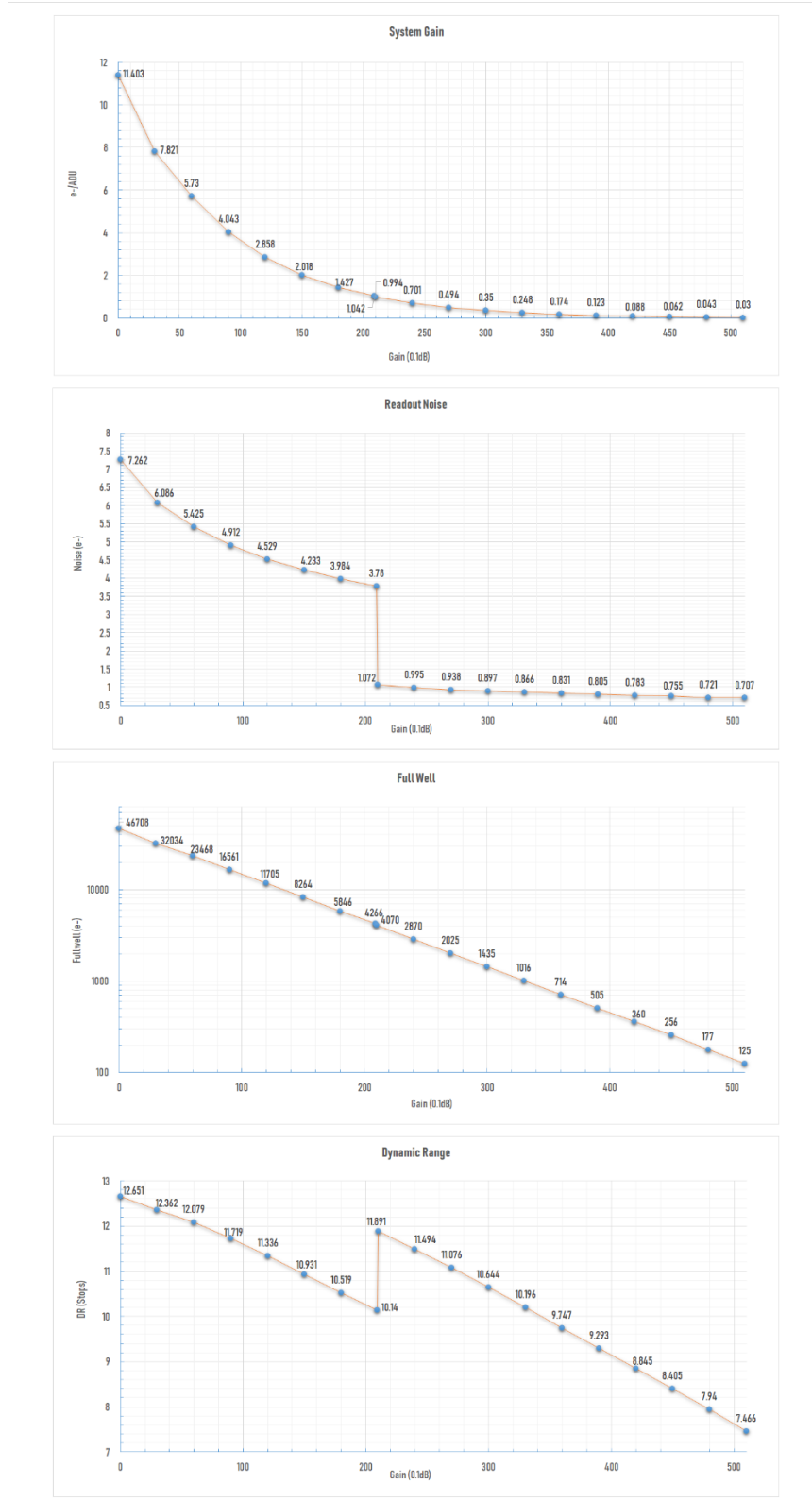

## Readout Noise

Regarding readout noise, we solemnly promise that all values are obtained from actual tests. And for users, you could use Sharpcap 4 for testing. SC4 has a function called **Sensor Analysis**, provide a very simple way to test readout noise.

We wrote a tutorial on our website: <https://player-one-astronomy.com/service/manuals/>

If you are interested in readout noise testing, you may try it yourself, which is very simple.

## Dark current

The dark current is only 0.0004 e/s/pix at -20°C, and 0.005e/s/pix at 0°C.

In entire curve, dark current is almost like a straight a line, which can prove that Uranus-C PRO camera has very good quality and stable performance.

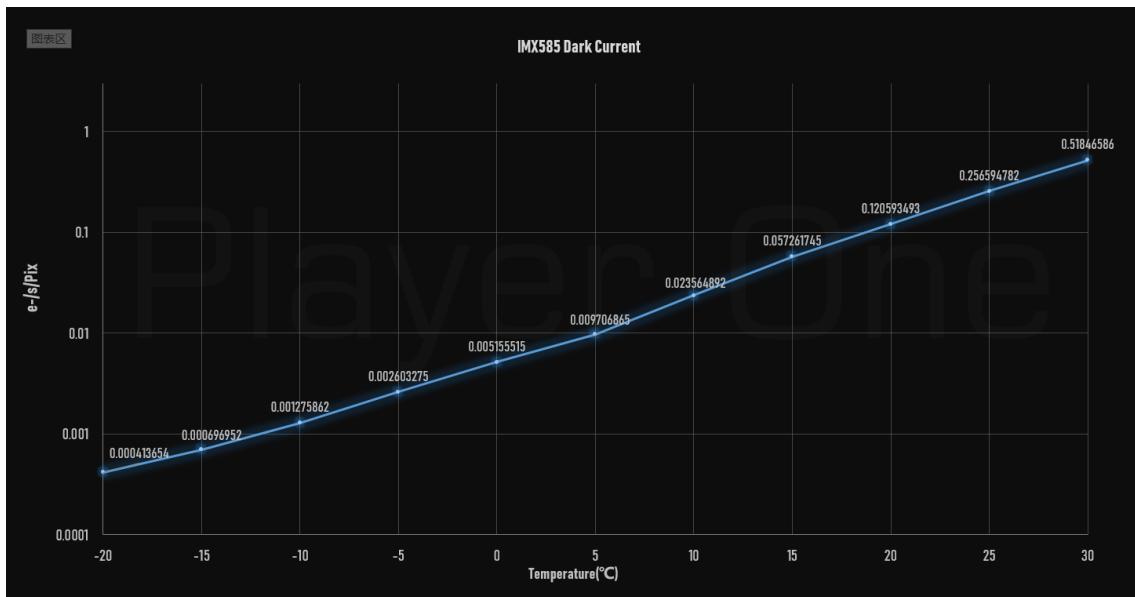

Relative QE Curve

### IMX585 QE Curve

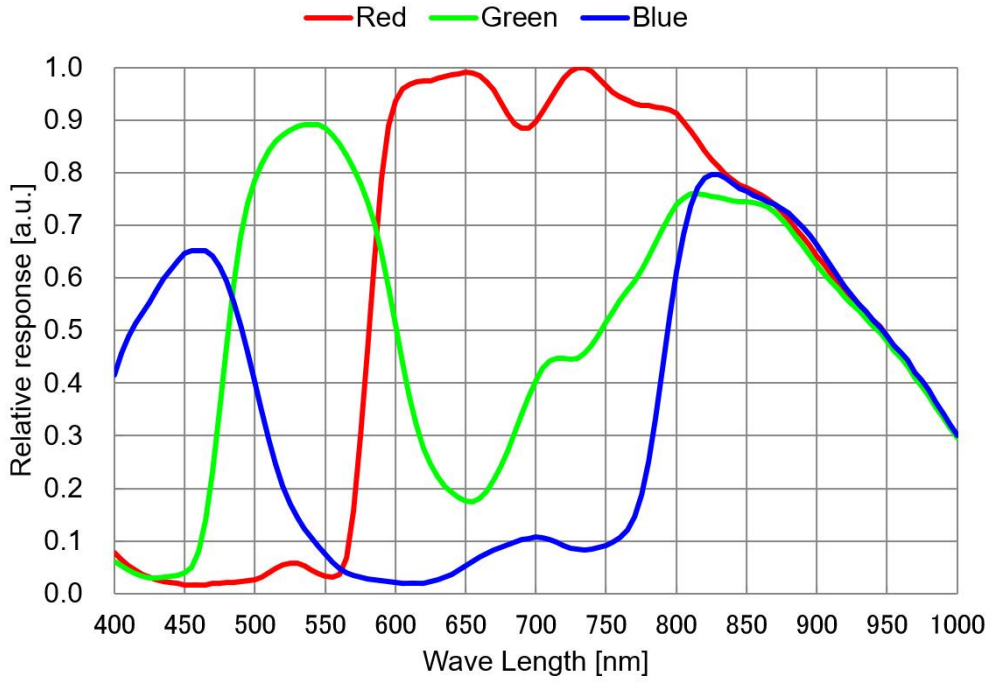

## Mechanical Drawing

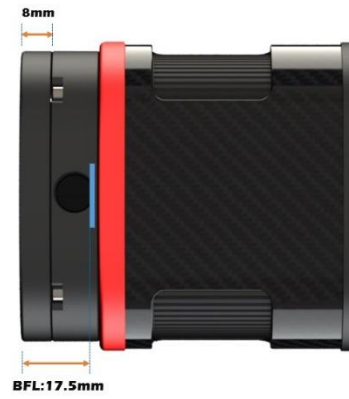
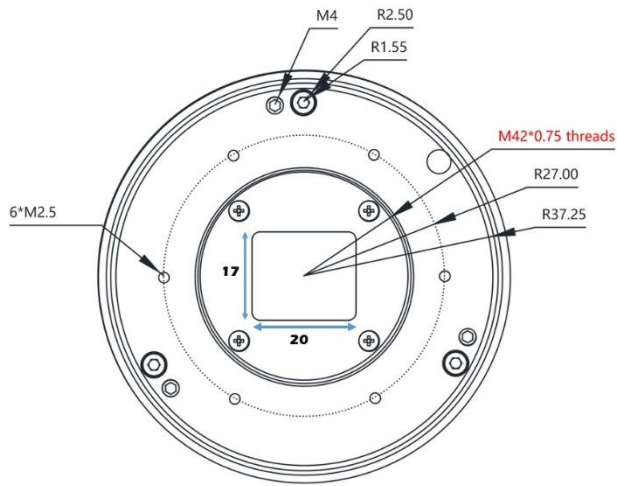



## BFL Solutions

Following is some recommend 55mm BFL solution for this camera. If don't consider about BFL, the connection way is various.

### Uranus-C PRO camera Basic BFL solution

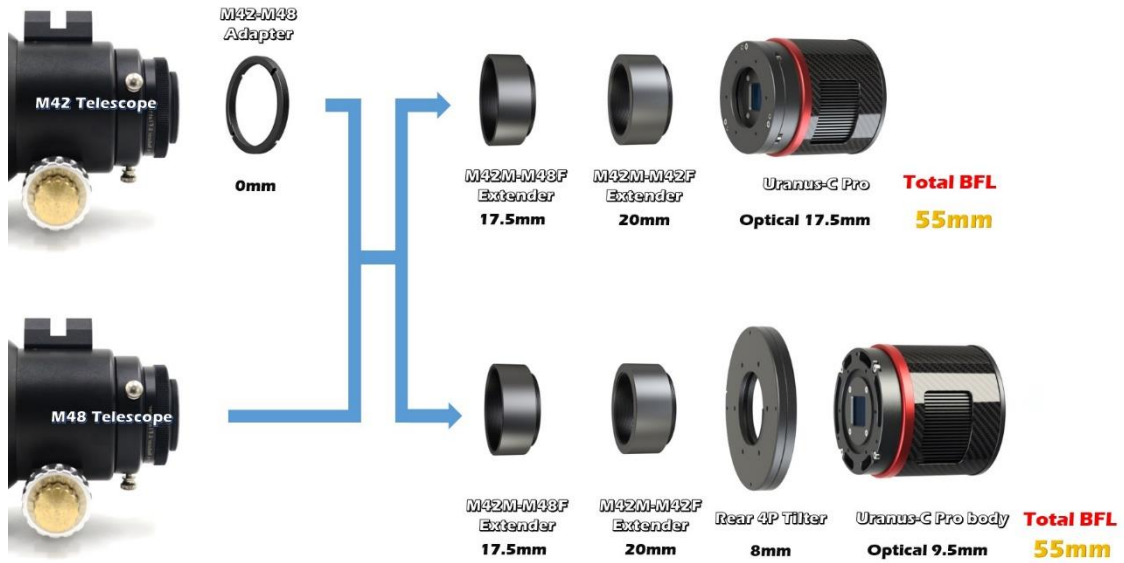

### Uranus-C PRO camera + Filter Drawer MINI BFL solution

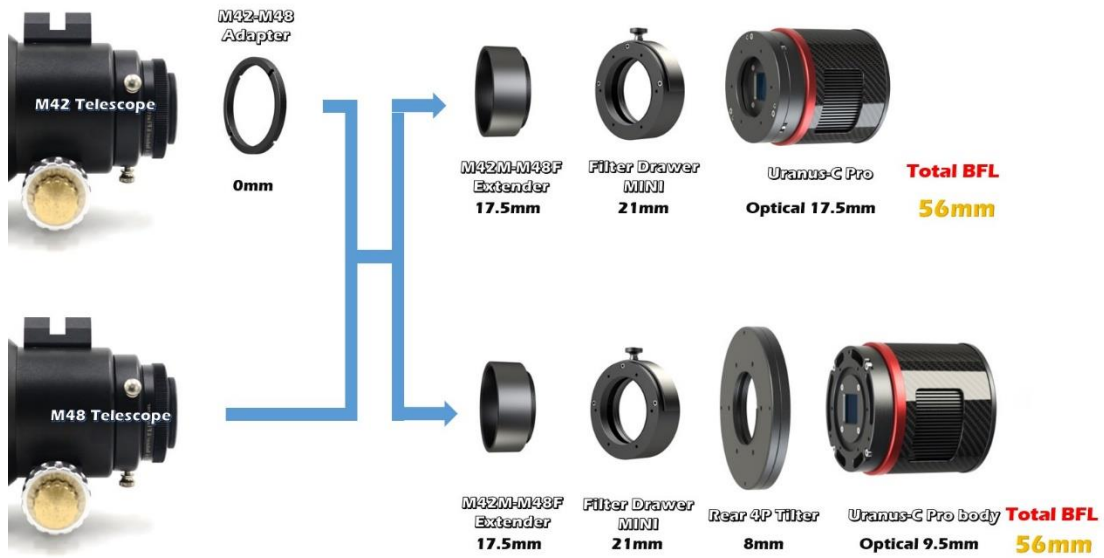

**Uranus-C PRO camera + Filter Drawer MINI + FHD-OAG MINI BFL solution**















**Notice: Some BFL solution is 56mm (Compensate light path differences which caused by filters)**

## Package List



## Camera package

<p>1</p>  <p>Camera + Metal Cover</p>	<p>2</p>  <p>M48F-M42M Extender 17.5mm</p>	<p>3</p>  <p>M42F-M42M Extender 20mm</p>	<p>4</p>  <p>M48M-M42F Adapter 0mm</p>
<p>5</p>  <p>T-mount and 1.25" Cover</p>	<p>6</p>  <p>Air Blower</p>	<p>7</p>  <p>Type-C to Type-A 2M USB3.2 Cable</p>	<p>8</p>  <p>Type-C to Type-C 0.5M USB2.0 Cable</p>
<p>9</p>  <p>Type-C to Type-B 0.5M USB2.0 Cable</p>	<p>10</p>  <p>Screwdriver x1 M2 Hexagonal Wrench x1 A bag of M2.5 screw</p>	<p>11</p>  <p>Rear 4P tilter</p>	<p>12</p>  <p>Camera Bag Cable Tie</p>

## Warranty & Shipping Policy

### Payment method

We provide *PayPal* and *PayPal checkout* on our website.

### Shipping and Delivery

#### Shipping Fee:

- Amount  $\geq$  299USD: free express shipping
- Amount  $<$  299USD: 29.9USD for express shipping

#### Shipping Services:

- We usually use DHL, UPS, FedEx, TNT for shipping.
- Make sure your email is correct, we maybe will contact with you through emails in case of emergency.

If customer wants to designate a shipping company or has special requirement, please send an email to [support@player-one-astronomy.com](mailto:support@player-one-astronomy.com) and tell us your detailed requirement.

#### Shipping time:

- Usually 7-14 days.
- Tracking number will be updated in 3 days after paid.

For orders from areas where transportation is not easy, such as islands, town in mountainous regions, delivery time will be slightly longer.

Please send an email to [support@player-one-astronomy.com](mailto:support@player-one-astronomy.com) immediately, if the following occurs:

- Shipping delayed or has some abnormal information.
- The packing is badly damaged on arrival, take pictures and do not sign.

### Tax

- The price on our website without tax.
- Please note that buyers are liable to charge tax involved, such as Import tax, VAT, customs handling fee, etc.
- Those fees possibly will be collected at the time of delivery by courier.

For best experiences, we recommend customers to purchase our products form local dealers.

### After-sales Service

#### Warranty Policy

2-year free warranty (time start from delivered) for Player One products. If the product has any issue, please send the image or video and description to [support@player-one-astronomy.com](mailto:support@player-one-astronomy.com) for further check to confirm.

- Purchase from Player One official online store, we will provide warranty service directly.
- Purchase form dealer, we will provide warranty service through dealer.

Repair in warranty, customer only pay the shipping fee of shipping back the product to us or dealer, and no other extra fees.

### **Replacement Policy**

You can request our Replacement Service:

- √ Within 30 calendar days of receiving the product if the product does not match the original description of the product in one or more significant respects.
- √ Within 30 calendar days of receiving the product if the product suffers performance failure.

Please contact our After-Sales team by email to *support@player-one-astronomy.com* within 30 calendar days of receiving the products. Player One shall be responsible for the two-way replacement freight for any products sent in for replacement due to performance faults.

### **Warranty and Replacement Policy Exceptions:**

- × Warranty service time or replacement service time expired.
- × Legal proof-of-purchase, receipts, or invoices are not provided, or are reasonably believed to have been forged or tampered with.
- × A product sent to Player One for replacement does not include all original accessories, attachments and packaging, or contains items damaged by user error.
- × A product is found to have no defects after all appropriate tests are conducted by Player One.
- × Any fault or damage of the product is caused by unauthorized use or modification of the product, including exposure to moisture, entry of foreign bodies (water, oil, sand, etc.) or improper installation or operation.
- × Product labels or serial numbers show signs of tampering or alteration.
- × Damage is caused by uncontrollable external factors, including falling down, fires, floods, or lightning strikes, etc.
- × Proof of damage during transit issued by the carrier cannot be provided.
- × Other circumstances stated in this policy.

In those situations, repair the product might have extra cost, we will estimate cost and email customer to know the information before send product back.